

All containers are equipped with two label holders on the 40cm-side.  
 The measurements of the holders are (from left to right) 91 and 82 mm.

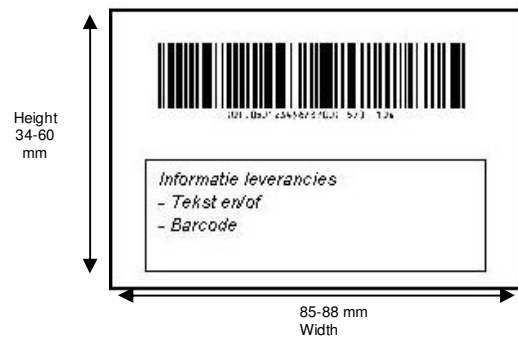
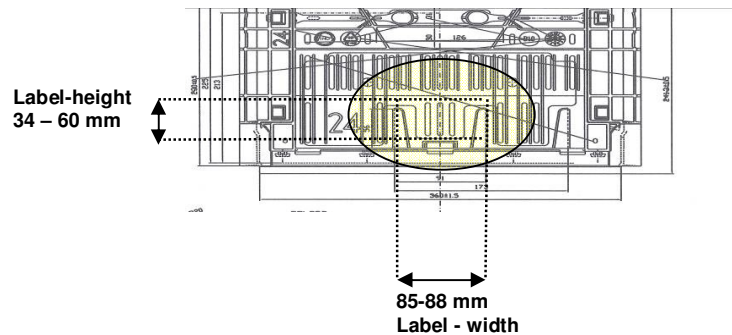
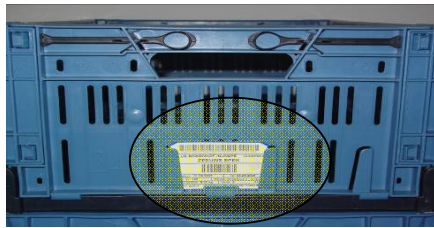

Green foldable containers	Label height *)
246/216/186/156/154	Up to 60 mm
136	Up to 50 mm
106/104	between 34 - 35 mm

Blue foldable containers	Label height
24/18/13/46	60 mm
610/410	between 34 - 35 mm

Blue rigid containers	Label height
H/M/L/T	60 mm

\*) Cardboard specification: 170 – 220 g/m<sup>2</sup>

The labels can't cover the handling areas. This is to prevent losing labels or hands getting injured by label cuts.

Example and drawings of cardboard labels:

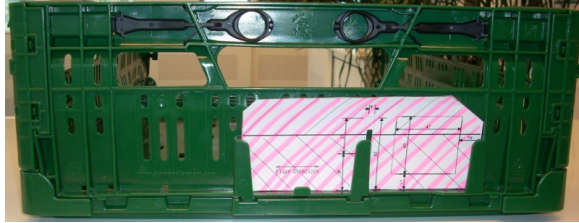

Up to 60 mm – 246/216/186/156/154 crates

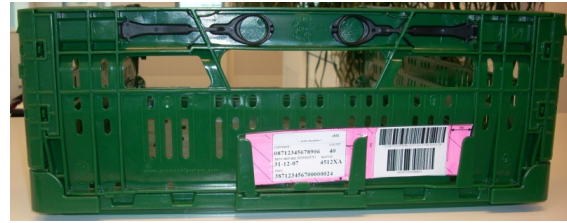

up to 60 mm – 246/216/186/156/154 crates

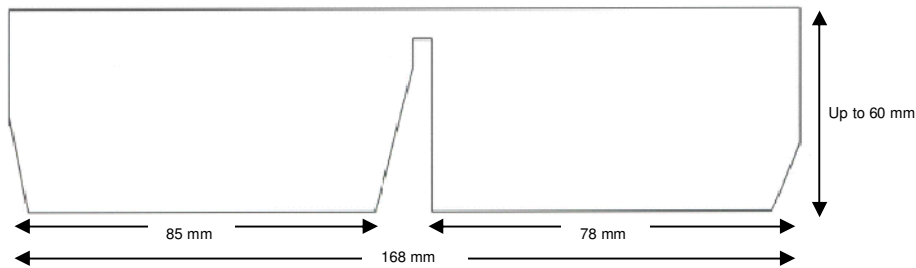
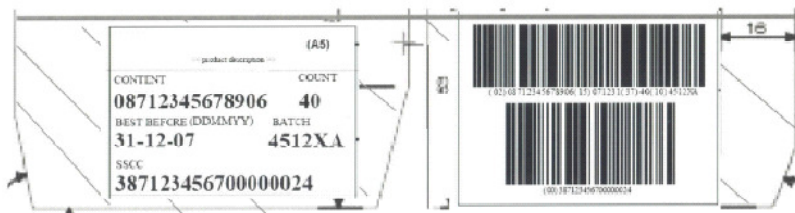

Up to 34 mm – Label example Germany – 106/104 crates

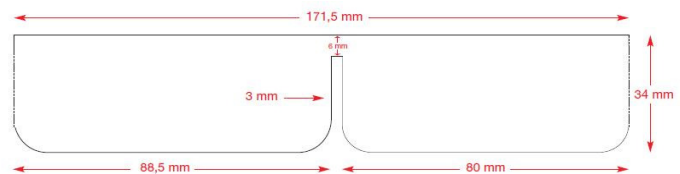

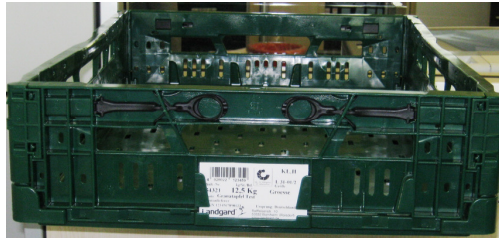

Up to 50mm – label example Germany - 136 crate

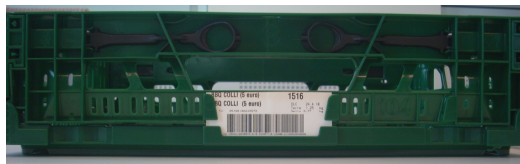
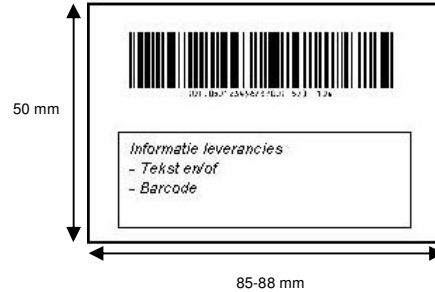

Between 34 – 35 mm - label example Belgium – 106/104/610/410 crates

